

A top-down view of a lush green field of clover plants. A horizontal orange bar with rounded ends spans across the middle of the image. On the left side of this bar, the number '2' is printed in a bold, black, sans-serif font inside a white rounded square.

2

**INKAPSCHELLEN
COQUILLES À ENCASTRER**



400

HDD★PRO



INKAPSCHELP HDD HALVE MAAN MASSIEF INOX PLUS/
COQUILLE A ENCASTRER HDD DEMI LUNE MASSIF INOX PLUS

ART. 3.120.000 P.404

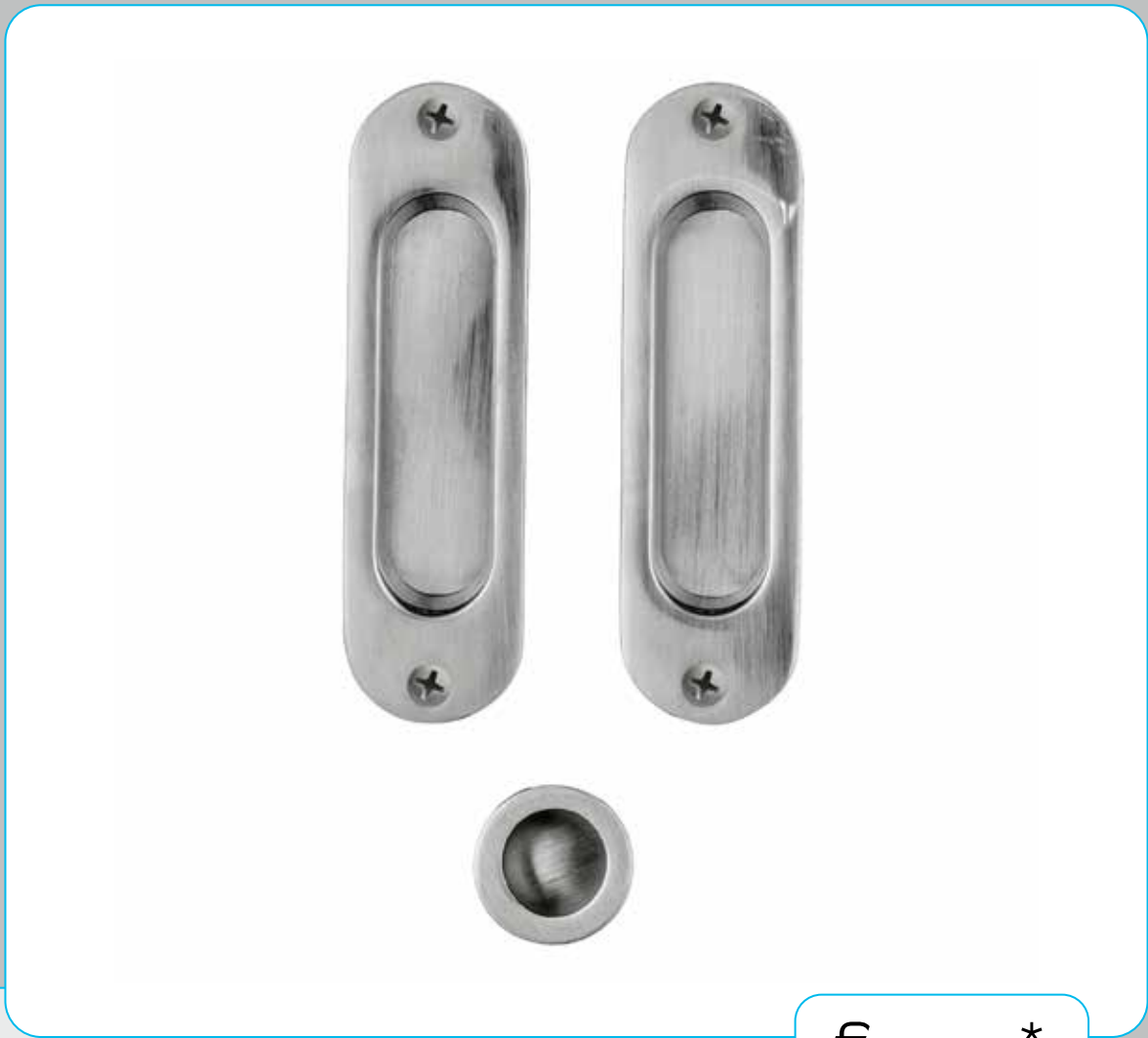

€ *

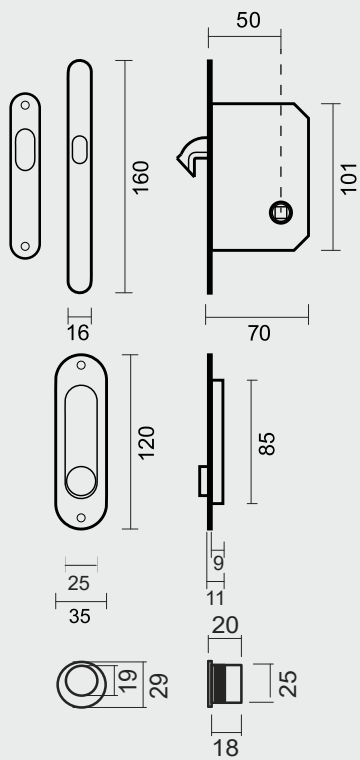

- INKAPSCHELP **FRA OVAAL INOX LOOK**
- COQUILLE A ENCASTRER **FRA OVALE INOX LOOK**
- ART. **3.126.000**
(per set/le set)
INCL. **4X** **15MM**

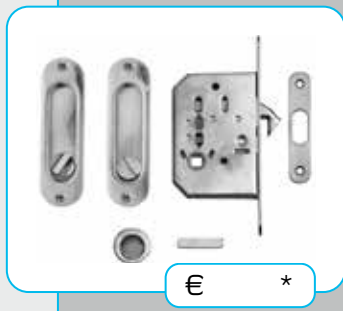

€ *

- INKAPSCHELP **FRA OVAAL+SLOT INOX LOOK**
- COQUILLE A ENCASTRER **FRA OVALE+SERRURE INOX LOOK**
- ART. **3.126.002**
(per set/le set)
INCL. **8X** **15MM**

INKAPSCHELP FRA
ROND INOX LOOK

COQUILLE A ENCASTRER FRA
RONDE INOX LOOK

ART. **3.127.000**
 (per set/le set)

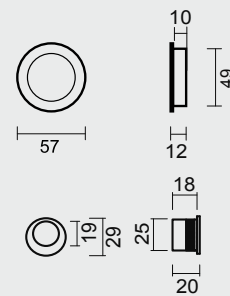

PRO★FINISH
 100% ITALIAN MANUFACTURE

€ *

INKAPSCHELP HDD
KLEIN ROND INOX PLUS

COQUILLE A ENCASTRER HDD
PETITE RONDE INOX PLUS

ART. **3.123.000**
 (per stuk/la piece)

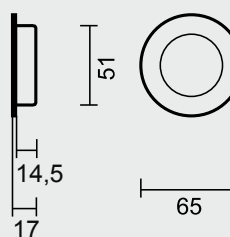

PRO★INOX PLUS
 PROFESSIONAL QUALITY LABEL

€ *

INKAPSCHELP HDD
GROOT ROND INOX PLUS

COQUILLE A ENCASTRER HDD
GRANDE RONDE INOX PLUS

ART. **3.122.000**
 (per stuk/la piece)

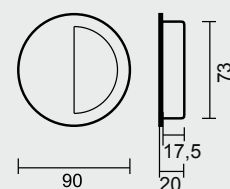

PRO★INOX PLUS
 PROFESSIONAL QUALITY LABEL

€ *

INKAPSCHELP HDD
OVAAL BLIND INOX PLUS

COQUILLE A ENCASTRER HDD
OVALE AVEUGLE INOX PLUS

ART. **3.538.000**
 (per stuk/la piece)

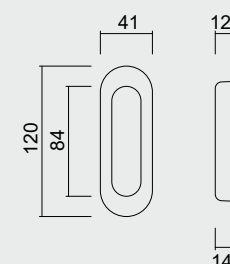

PRO★INOX PLUS
 PROFESSIONAL QUALITY LABEL

€ *

Technical drawing showing dimensions: 60x60mm square face, 12mm height, 49mm total height, 10mm mounting hole offset, 18mm hole diameter, 25mm hole offset, and 20mm hole diameter.

PRO★FINISH
100% ITALIAN MANUFACTURE

€ *

**INKAPSCHELP FRA
CARRE INOX LOOK**

**COQUILLE A ENCASTRER FRA
CARREE INOX LOOK**

ART. 3.128.000
(per set/le set)

Technical drawing showing dimensions: 55mm square face, 18mm height, 46mm total height, and 16mm mounting hole offset.

PRO★INOX PLUS
PROFESSIONAL QUALITY LABEL

€ *

**INKAPSCHELP HDD
ROND CARRE INOX PLUS**

**COQUILLE A ENCASTRER HDD
RONDE CARREE INOX PLUS**

ART. 3.124.000
(per stuk/la piece)

Technical drawing showing dimensions: 102mm height, 88mm inner height, 16mm top offset, 14mm top thickness, 37mm hole width, and 51mm hole offset.

PRO★INOX PLUS
PROFESSIONAL QUALITY LABEL

€ *

**INKAPSCHELP HDD
OVAAL CARRE INOX PLUS**

**COQUILLE A ENCASTRER HDD
OVALE CARREE INOX PLUS**

ART. 3.125.000
(per stuk/la piece)

Technical drawing showing dimensions: 120mm height, 80mm inner height, 40mm hole width, 11mm top offset, and 13mm bottom offset.

PRO★INOX PLUS
PROFESSIONAL QUALITY LABEL

€ *

**INKAPSCHELP HDD
OVAAL CARRE SMAL BLIND INOX PLUS**

**COQUILLE A ENCASTRER HDD
OVALE CARREE FIN AVEUGLE INOX PLUS**

ART. 3.539.000
(per stuk/la piece)

INKAPSCHELP **HDD**
HALVE MAAN MASSIEF INOX PLUS

COQUILLE A ENCASTRER **HDD**
DEMI LUNE MASSIF INOX PLUS

A = 38MM: €	* = ART. 3.530.000
A = 40MM: €	* = ART. 3.120.000
A = 41,5MM: €	* = ART. 3.529.000
A = 43MM: €	* = ART. 3.921.000
A = 50MM: €	* = ART. 3.528.000

(per stuk/la piece)

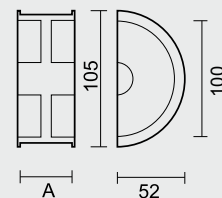

PRO★INOX PLUS
PROFESSIONAL QUALITY LABEL

INKAPSCHELP **HDD**
HALVE MAAN GLAS INOX PLUS

COQUILLE A ENCASTRER **HDD**
DEMI LUNE VERRE INOX PLUS

A = 8MM: €	* = ART. 3.402.000
A = 10MM: €	* = ART. 3.403.000
A = 12MM: €	* = ART. 3.448.000

(per stuk/la piece)

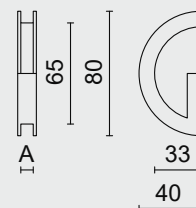

infrezing/fraisage:
35 x 68

PRO★INOX PLUS
PROFESSIONAL QUALITY LABEL

INKAPSCHELP **FRA**
VINGERTOP INOX LOOK

COQUILLE A ENCASTRER **FRA**
POINTE DE DOIGT INOX LOOK

ART. **3.446.000**
(per stuk/la piece)

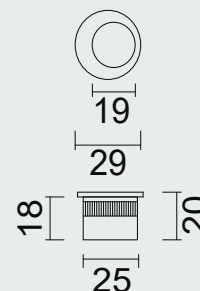

PRO★FINISH
100% ITALIAN MANUFACTURE

€ *

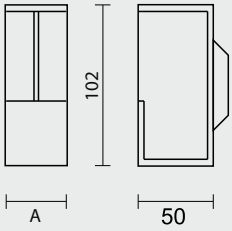

**INKAPSCHELP HDD
CARRE MASSIEF INOX PLUS**

**COQUILLE A ENCASTRER HDD
CARREE MASSIF INOX PLUS**

- A = 40MM: € * = ART. **3.119.000**
- A = 43MM: € * = ART. **3.447.000**
- A = 50MM: € * = ART. **3.554.000**
(per stuk/la piece)

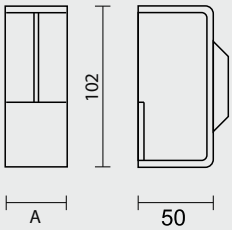

**INKAPSCHELP HDD
CARRE MASSIEF AFGEROND INOX PLUS**

**COQUILLE A ENCASTRER HDD
CARREE MASSIF ARRONDIE INOX PLUS**

- A = 40MM: € * = ART. **3.580.000**
- A = 43MM: € * = ART. **3.581.000**
- A = 50MM: € * = ART. **3.582.000**
(per stuk/la piece)

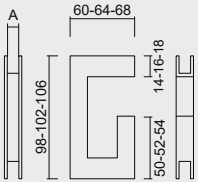

infrezing/fraisage:
A = 8 mm: 51 x 79
A = 10 mm: 53 x 79
A = 12 mm: 55 x 79



**INKAPSCHELP HDD
CARRE GLAS INOX PLUS**

**COQUILLE A ENCASTRER HDD
CARREE VERRE INOX PLUS**

- A = 8MM: € * = ART. **3.493.000**
- A = 10MM: € * = ART. **3.494.000**
- A = 12MM: € * = ART. **3.495.000**
(per stuk/la piece)

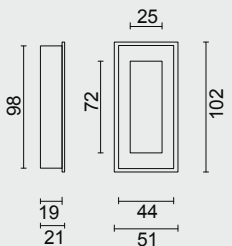

**INKAPSCHELP HDD
CLOSED INOX PLUS**

**COQUILLE A ENCASTRER HDD
CLOSED INOX PLUS**

- ART. **3.400.000**
(per stuk/la piece)

€ *

INKAPSCHELP FRA
OVAAL CARRE INOX LOOK

COQUILLE A ENCASTRER FRA
OVALE CARREE INOX LOOK

ART. **3.469.000**
(per set./le set)

INCL. 4X  15MM

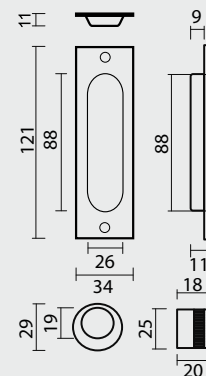

PRO FINISH
100% ITALIAN MANUFACTURE

€ *

INKAPSCHELP FRA
RETRO OVAAL INOX LOOK

COQUILLE A ENCASTRER FRA
RETRO OVALE INOX LOOK

ART. **3.445.000**
(per set./le set)

INCL. 4X  15MM

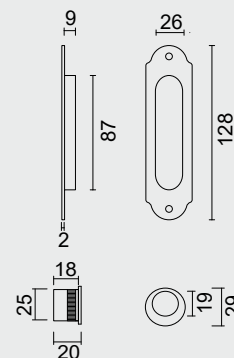

PRO FINISH
100% ITALIAN MANUFACTURE

€ *

INKAPSCHELP FRA
RETRO CARRE INOX LOOK

COQUILLE A ENCASTRER FRA
RETRO CARREE INOX LOOK

ART. **3.444.000**
(per set./le set)

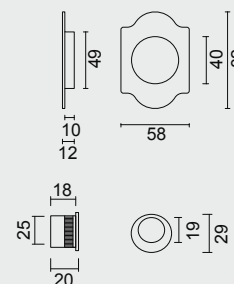

PRO FINISH
100% ITALIAN MANUFACTURE

€ *

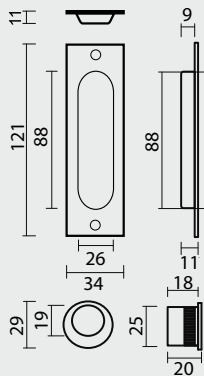

PRO FINISH
100% ITALIAN MANUFACTURE

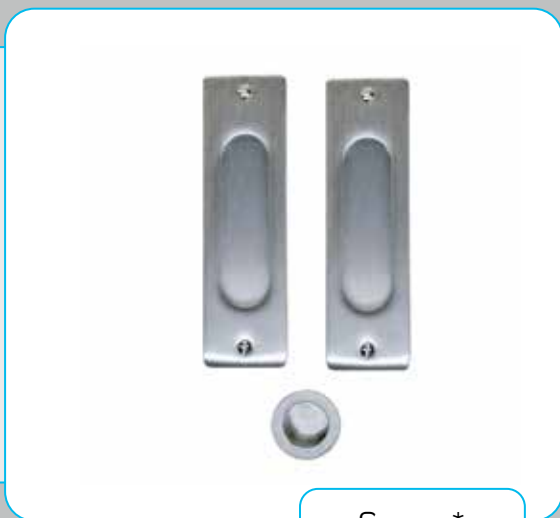

€ *

INKAPSCHELP FRA OVAAL
CARRE CROMSAT

COQUILLE A ENCASTRER FRA
OVALE CARREE CROMSAT

ART. **3.469.340**
(per set/le set)

INCL. 4X 15MM

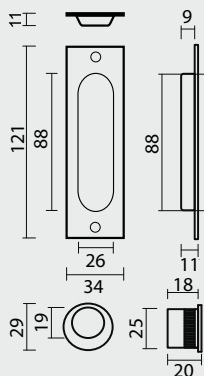

PRO FINISH
100% ITALIAN MANUFACTURE

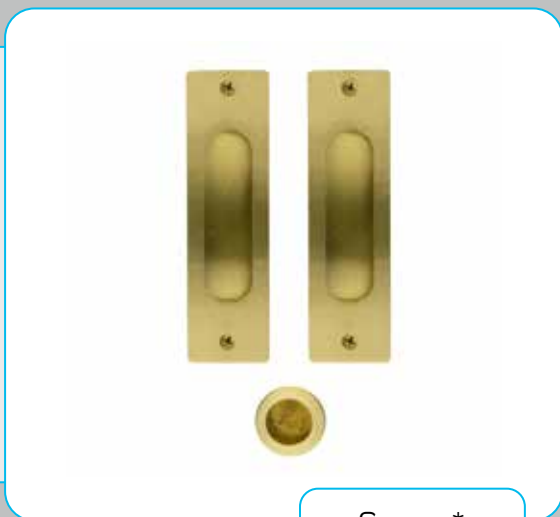

€ *

INKAPSCHELP FRA OVAAL
CARRE MAT KOPER

COQUILLE A ENCASTRER FRA
OVALE CARREE LAITON MAT

ART. **3.469.050**
(per set/le set)

INCL. 4X 15MM

BIJ GEBRUIK IS DE AFWERKING ONDERHEVIG AAN
KLEURVERANDERING / LORSQU'ELLE EST UTILISEE, LA FINITION
PEUT AVOIR UN CHANGEMENT DE COULEUR LOCAL

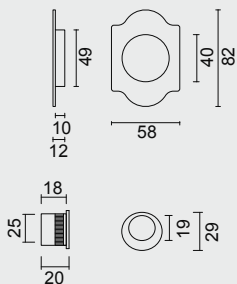

PRO FINISH
100% ITALIAN MANUFACTURE



€ *

INKAPSCHELP FRA RETRO
CARRE OLD BRASS

COQUILLE A ENCASTRER FRA
RETRO CARREE OLD BRASS

ART. **3.444.380**
(per set/le set)

INKAPSCHELP **HDD HALVE MAAN
MASSIEF WIT STRUCTUUR**

COQUILLE A ENCASTRER **HDD DEMI LUNE
MASSIF BLANC STRUCTURE**

A = 40MM: € * = ART. **3.120.100**

A = 43MM: € * = ART. **3.921.100**

A = 50MM: € * = ART. **3.528.100**
(per stuk/la piece)

MATTE STRUCTUUR AFWERKING/
FINITION STRUCTURE MATE

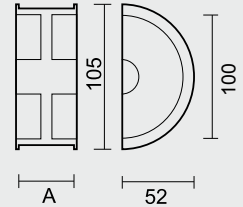

PRO INOX PLUS
PROFESSIONAL QUALITY LABEL

INKAPSCHELP **HDD CARRE MASSIEF
WIT STRUCTUUR**

COQUILLE A ENCASTRER **HDD CARREE
MASSIF BLANC STRUCTURE**

A = 40MM: € * = ART. **3.119.100**

A = 43MM: € * = ART. **3.447.100**

A = 50MM: € * = ART. **3.554.100**
(per stuk/la piece)

MATTE STRUCTUUR AFWERKING/
FINITION STRUCTURE MATE

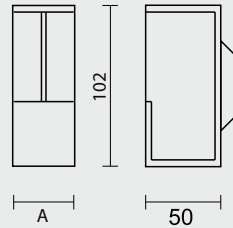

PRO INOX PLUS
PROFESSIONAL QUALITY LABEL

INKAPSCHELP **HDD CARRE MASSIEF
AFGEROND WIT STRUCTUUR**

COQUILLE A ENCASTRER **HDD CARREE MASSIF
ARRONDIE BLANC STRUCTURE**

A = 40MM: € * = ART. **3.580.100**

A = 43MM: € * = ART. **3.581.100**

A = 50MM: € * = ART. **3.582.100**
(per stuk/la piece)

MATTE STRUCTUUR AFWERKING/
FINITION STRUCTURE MATE

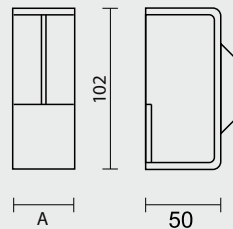

PRO INOX PLUS
PROFESSIONAL QUALITY LABEL

MATTE STRUCTUUR AFWERKING/
FINITION STRUCTURE MATE

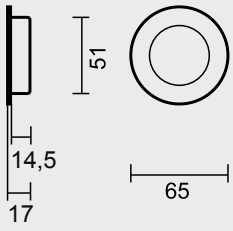

PRO★INOX PLUS
PROFESSIONAL QUALITY LABEL



€ *

INKAPSCHELP **HDD KLEIN ROND WIT STRUCTUUR**

COQUILLE A ENCASTRER **HDD PETITE RONDE BLANC STRUCTURE**

ART. **3.123.100**
(per stuk/la piece)

MATTE STRUCTUUR AFWERKING/
FINITION STRUCTURE MATE

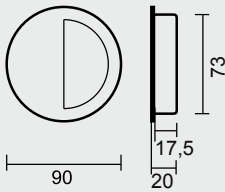

PRO★INOX PLUS
PROFESSIONAL QUALITY LABEL



€ *

INKAPSCHELP **HDD GROOT ROND WIT STRUCTUUR**

COQUILLE A ENCASTRER **HDD GRANDE RONDE BLANC STRUCTURE**

ART. **3.122.100**
(per stuk/la piece)

MATTE STRUCTUUR AFWERKING/
FINITION STRUCTURE MATE

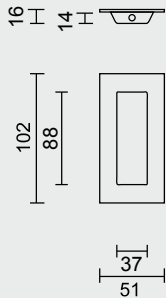

PRO★INOX PLUS
PROFESSIONAL QUALITY LABEL



€ *

INKAPSCHELP **HDD OVAAL CARRE WIT STRUCTUUR**

COQUILLE A ENCASTRER **HDD OVALE CARREE BLANC STRUCTURE**

ART. **3.125.100**
(per stuk/la piece)

RAL 9016 GLANZENDE AFWERKING/
FINITION BRILLANTE

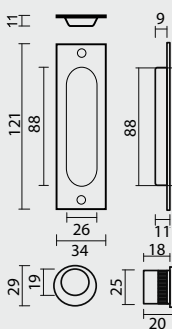

PRO★FINISH
100% ITALIAN MANUFACTURE



€ *

INKAPSCHELP **FRA OVAAL CARRE WIT**

COQUILLE A ENCASTRER **FRA OVALE CARREE BLANC**

ART. **3.469.390**
(per set/le set)

INCL. 4X  15MM

INKAPSCHELP
PANDA PVC WIT PER STUK

COQUILLE A ENCASTRER
PANDA PVC BLANC LA PIECE

ART. **3.129.390**
(per stuk/la piece)

€ *

PVC

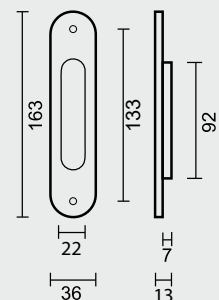

PRO★FINISH
100% ITALIAN MANUFACTURE

INKAPSCHELP
PANDA PVC LICHT GRIJS PER STUK

COQUILLE A ENCASTRER
PANDA PVC GRIS CLAIR LA PIECE

ART. **3.129.110**
(per stuk/la piece)

€ *

PVC

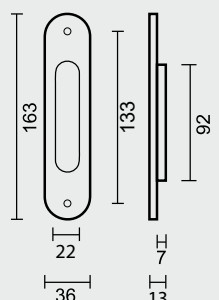

PRO★FINISH
100% ITALIAN MANUFACTURE

INKAPSCHELP
PANDA PVC DONKER GRIJS PER STUK

COQUILLE A ENCASTRER
PANDA PVC GRIS FONCE LA PIECE

ART. **3.129.120**
(per stuk/la piece)

€ *

PVC

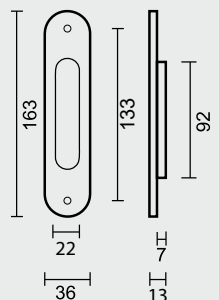

PRO★FINISH
100% ITALIAN MANUFACTURE

INKAPSCHELP
PANDA PVC ZWART PER STUK

COQUILLE A ENCASTRER
PANDA PVC NOIR LA PIECE

ART. **3.129.090**
(per stuk/la piece)

€ *

PVC

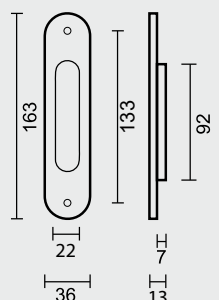

PRO★FINISH
100% ITALIAN MANUFACTURE



INKAPSCHELP **FRA**
OVAAL CARRE ZWART

COQUILLE A ENCASTRER **FRA**
OVALE CARREE NOIR

ART. **3.469.090**
(per set/le set)

INCL. **4X**  **15MM**

RAL 9005
MATTE AFWERKING/FINITION MATE

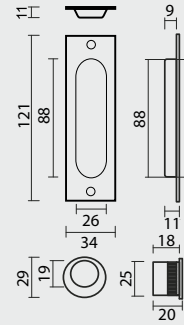

PRO★FINISH
100% ITALIAN MANUFACTURE

€ *

INKAPSCHELP **FRA**
OVAAL CARRE+SLIT ZWART

COQUILLE A ENCASTRER **FRA**
OVALE CARREE+SERRURE NOIR

ART. **3.469.092**
(per set/le set)

INCL. **8X**  **15MM**

RAL 9005
MATTE AFWERKING/FINITION MATE

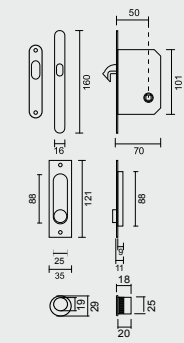

PRO★FINISH
100% ITALIAN MANUFACTURE

€ *

INKAPSCHELP **FRA**
CARRE ZWART

COQUILLE A ENCASTRER **FRA**
CARREE NOIR

ART. **3.128.090**
(per set/le set)

RAL 9005
MATTE AFWERKING/FINITION MATE

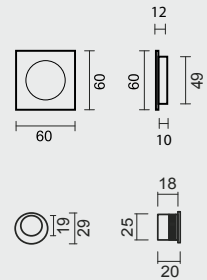

PRO★FINISH
100% ITALIAN MANUFACTURE

€ *

INKAPSCHELP **FRA**
RETRO CARRE ZWART

COQUILLE A ENCASTRER **FRA**
RETRO CARREE NOIR

ART. **3.444.090**
(per set/le set)

RAL 9005
MATTE AFWERKING/FINITION MATE

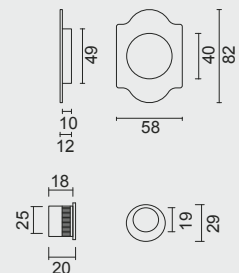

PRO★FINISH
100% ITALIAN MANUFACTURE

€ *

RAL 9005
MATTE AFWERKING/FINITION MATE

PRO FINISH
100% ITALIAN MANUFACTURE

€ *

INKAPSCHELP **FRA**
OVAAL ZWART

COQUILLE A ENCASTRER **FRA**
OVALE NOIR

ART. **3.126.090**
(per set./le set)

INCL. **4X** **15MM**

RAL 9005
MATTE AFWERKING/FINITION MATE

PRO FINISH
100% ITALIAN MANUFACTURE

€ *

INKAPSCHELP **FRA**
OVAAL+SLLOT ZWART

COQUILLE A ENCASTRER **FRA**
OVALE+SERRURE NOIR

ART. **3.126.092**
(per set./le set)

INCL. **8X** **15MM**

RAL 9005
MATTE AFWERKING/FINITION MATE

PRO FINISH
100% ITALIAN MANUFACTURE

€ *

INKAPSCHELP **FRA**
ROND ZWART

COQUILLE A ENCASTRER **FRA**
RONDE NOIR

ART. **3.127.090**
(per set./le set)

RAL 9005
MATTE AFWERKING/FINITION MATE

PRO FINISH
100% ITALIAN MANUFACTURE

€ *

INKAPSCHELP **FRA**
RETRO OVAAL ZWART

COQUILLE A ENCASTRER **FRA**
RETRO OVALE NOIR

ART. **3.445.090**
(per set./le set)

INCL. **4X** **15MM**

INKAPSCHELP **HDD**
HALVE MAAN GLAS ZWART

COQUILLE A ENCASTRER **HDD**
DEMI LUNE VERRE NOIR

A = 8MM: €	* = ART. 3.402.090
A = 10MM: €	* = ART. 3.403.090
A = 12MM: €	* = ART. 3.448.090

(per stuk/la piece)

MATTE AFWERKING/FINITION MATE

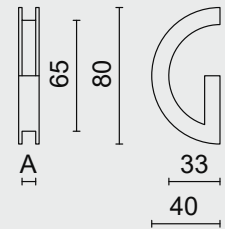

infrezing/fraisage:
35 x 68

PRO★INOX PLUS
PROFESSIONAL QUALITY LABEL

INKAPSCHELP **HDD**
CARRE GLAS ZWART

COQUILLE A ENCASTRER **HDD**
CARREE VERRE NOIR

A = 8MM: €	* = ART. 3.493.090
A = 10MM: €	* = ART. 3.494.090
A = 12MM: €	* = ART. 3.495.090

(per stuk/la piece)

MATTE AFWERKING/FINITION MATE

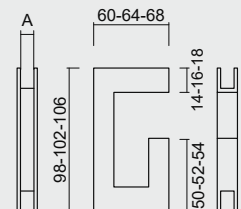

infrezing/fraisage:
A = 8 mm: 51 x 79
A = 10 mm: 53 x 79
A = 12 mm: 55 x 79

PRO★INOX PLUS
PROFESSIONAL QUALITY LABEL

MATTE AFWERKING/FINITION MATE

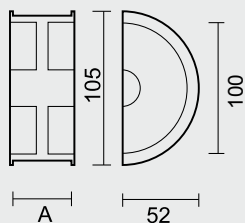
PRO INOX PLUS
 PROFESSIONAL QUALITY LABEL

**INKAPSCHELP HDD
 HALVE MAAN MASSIEF ZWART**
**COQUILLE A ENCASTRER HDD
 DEMI LUNE MASSIF NOIR**

 A = 40MM: € * = ART. **3.120.090**

 A = 43MM: € * = ART. **3.921.090**

 A = 50MM: € * = ART. **3.528.090**

(per stuk/la piece)

MATTE AFWERKING/FINITION MATE

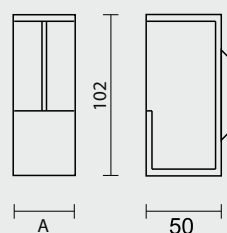
PRO INOX PLUS
 PROFESSIONAL QUALITY LABEL

**INKAPSCHELP HDD
 CARRE MASSIEF ZWART**
**COQUILLE A ENCASTRER HDD
 CARREE MASSIF NOIR**

 A = 40MM: € * = ART. **3.119.090**

 A = 43MM: € * = ART. **3.447.090**

 A = 50MM: € * = ART. **3.554.090**

(per stuk/la piece)

MATTE AFWERKING/FINITION MATE

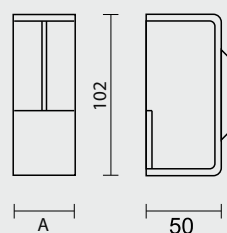
PRO INOX PLUS
 PROFESSIONAL QUALITY LABEL

**INKAPSCHELP HDD
 CARRE MASSIEF AFGEROND ZWART**
**COQUILLE A ENCASTRER HDD
 CARREE MASSIF ARRONDIE NOIR**

 A = 40MM: € * = ART. **3.580.090**

 A = 43MM: € * = ART. **3.581.090**

 A = 50MM: € * = ART. **3.582.090**

(per stuk/la piece)

INKAPSCHELP **FRA**
VINGERTOP ZWART

COQUILLE A ENCASTRER **FRA**
POINTE DE DOIGT NOIR

ART. **3.446.090**
(per stuk/la piece)

RAL 9005
MATTE AFWERKING/FINITION MATE

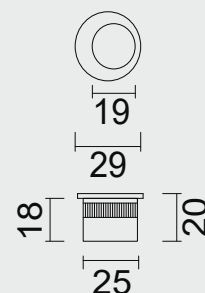

PRO★FINISH
100% ITALIAN MANUFACTURE

€ *

INKAPSCHELP **HDD**
KLEIN ROND ZWART

COQUILLE A ENCASTRER **HDD**
PETITE RONDE NOIR

ART. **3.123.090**
(per stuk/la piece)

MATTE AFWERKING/FINITION MATE

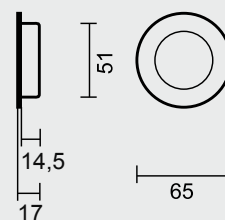

PRO★INOX PLUS
PROFESSIONAL QUALITY LABEL

€ *

INKAPSCHELP **HDD**
GROOT ROND ZWART

COQUILLE A ENCASTRER **HDD**
GRANDE RONDE NOIR

ART. **3.122.090**
(per stuk/la piece)

MATTE AFWERKING/FINITION MATE

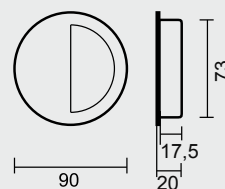

PRO★INOX PLUS
PROFESSIONAL QUALITY LABEL

€ *



MATTE AFWERKING/FINITION MATE

PRO INOX PLUS
PROFESSIONAL QUALITY LABEL

€ *

INKAPSCHELP HDD
OVAAL BLIND ZWART

COQUILLE A ENCASTRER HDD
OVALE AVEUGLE NOIR

ART. **3.538.090**
(per stuk/la piece)

MATTE AFWERKING/FINITION MATE

PRO INOX PLUS
PROFESSIONAL QUALITY LABEL

€ *

INKAPSCHELP HDD
OVAAL CARRE SMAL BLIND ZWART

COQUILLE A ENCASTRER HDD
OVALE CARREE FIN AVEUGLE NOIR

ART. **3.539.090**
(per stuk/la piece)

MATTE AFWERKING/FINITION MATE

PRO INOX PLUS
PROFESSIONAL QUALITY LABEL

€ *

INKAPSCHELP HDD
OVAAL CARRE ZWART

COQUILLE A ENCASTRER HDD
OVALE CARREE NOIR

ART. **3.125.090**
(per stuk/la piece)

INKAPSCHELP **FRA**
OVAAL NIKKEL

COQUILLE A ENCASTRER **FRA**
OVALE NICKEL BRILLANT

ART. **3.126.020**
(per set./le set)

INCL. **4X**  **15MM**

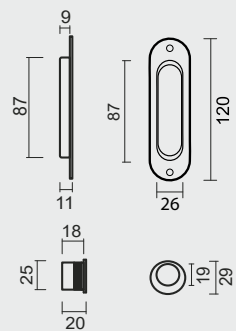

PRO★FINISH
100% ITALIAN MANUFACTURE

€ *

INKAPSCHELP **FRA**
OVAAL+SLOT NIKKEL

COQUILLE A ENCASTRER **FRA**
OVALE+SERRURE NICKEL BRILLANT

ART. **3.126.022**
(per set./le set)

INCL. **8X**  **15MM**

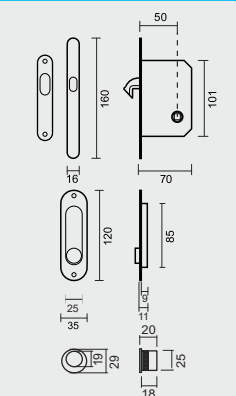

PRO★FINISH
100% ITALIAN MANUFACTURE

€ *

INKAPSCHELP **FRA**
RETRO OVAAL NIKKEL

COQUILLE A ENCASTRER **FRA**
RETRO OVALE NICKEL BRILLANT

ART. **3.445.020**
(per set./le set)

INCL. **4X**  **15MM**

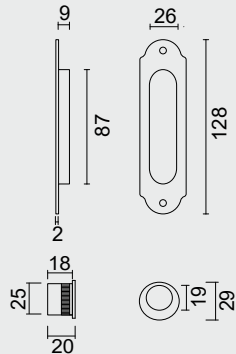

PRO★FINISH
100% ITALIAN MANUFACTURE

€ *

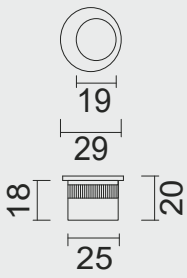

PRO FINISH
100% ITALIAN MANUFACTURE



€ *

INKAPSCHELP **FRA**
VINGERTOP NIKKEL

COQUILLE A ENCASTRER **FRA**
POINTE DE DOIGT NICKEL BRILLANT

ART. **3.446.020**
(per stuk/la piece)

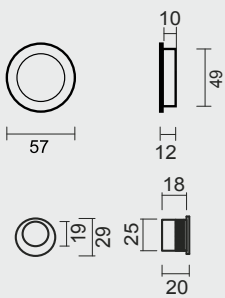

PRO FINISH
100% ITALIAN MANUFACTURE

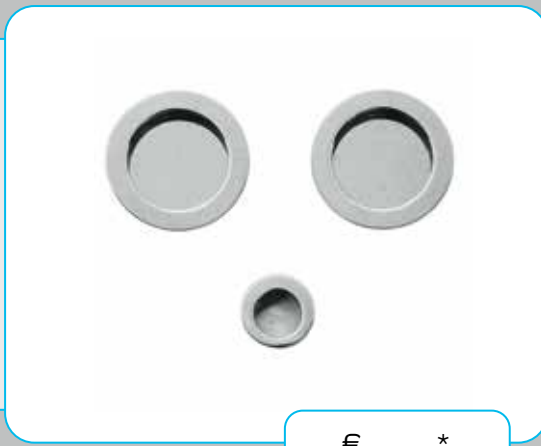

€ *

INKAPSCHELP **FRA**
ROND NIKKEL

COQUILLE A ENCASTRER **FRA**
RONDE NICKEL BRILLANT

ART. **3.127.020**
(per set/le set)

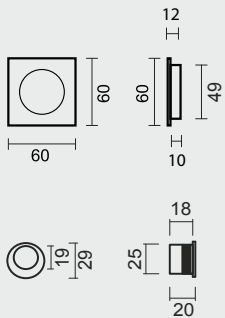

PRO FINISH
100% ITALIAN MANUFACTURE

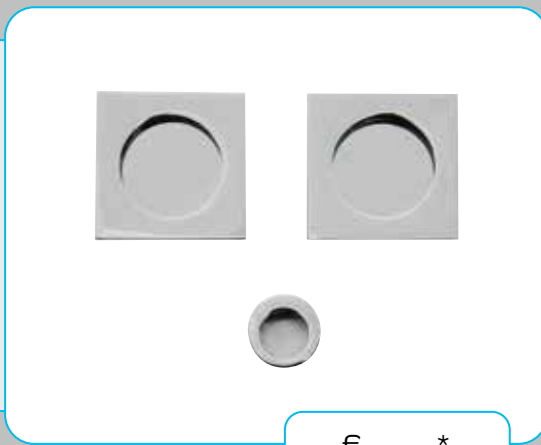

€ *

INKAPSCHELP **FRA**
CARRE NIKKEL

COQUILLE A ENCASTRER **FRA**
CARREE NICKEL BRILLANT

ART. **3.128.020**
(per set/le set)

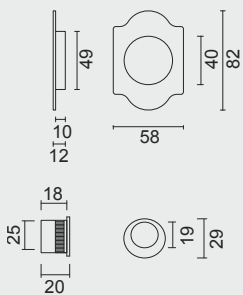

PRO FINISH
100% ITALIAN MANUFACTURE



€ *

INKAPSCHELP **FRA**
RETRO CARRE NIKKEL

COQUILLE A ENCASTRER **FRA**
RETRO CARREE NICKEL BRILLANT

ART. **3.444.020**
(per set/le set)

**INKAPSCHELP FRA
VINGERTOP OLD SILVER**

**COQUILLE A ENCASTRER FRA
POINTE DE DOIGT OLD SILVER**

ART. **3.446.300**
(per stuk/la piece)

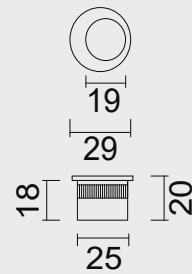
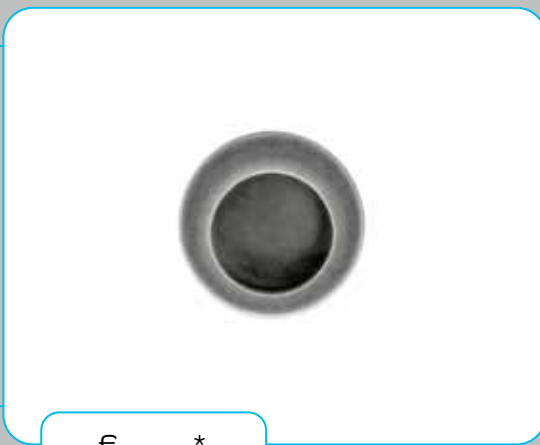

PRO★FINISH
100% ITALIAN MANUFACTURE

€ *

**INKAPSCHELP FRA
RETRO CARRE OLD SILVER**

**COQUILLE A ENCASTRER FRA
RETRO CARREE OLD SILVER**

ART. **3.444.300**
(per set/le set)

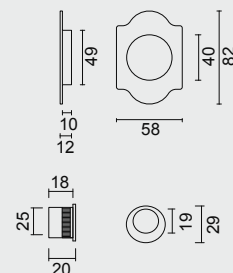
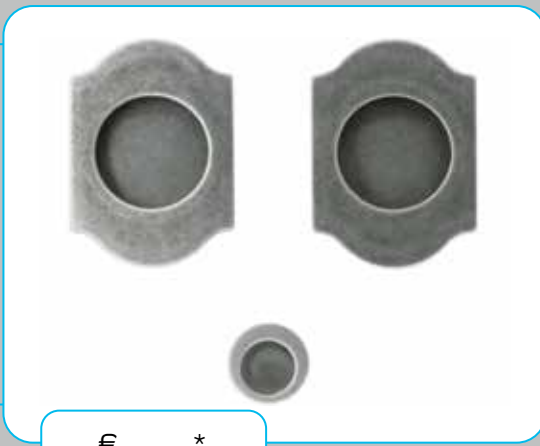

PRO★FINISH
100% ITALIAN MANUFACTURE

€ *

**INKAPSCHELP FRA
RETRO OVAAL OLD SILVER**

**COQUILLE A ENCASTRER FRA
RETRO OVALE OLD SILVER**

ART. **3.445.300**
(per set/le set)

INCL. **4X** **15MM**

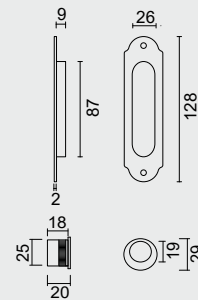
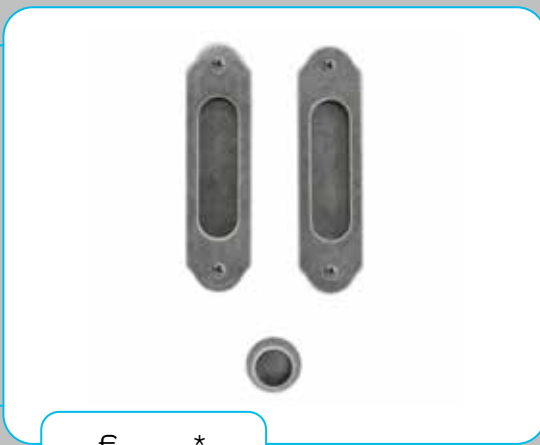

PRO★FINISH
100% ITALIAN MANUFACTURE

€ *

**INKAPSCHELP HDD
HALVE MAAN MASSIEF OLD SILVER**

**COQUILLE A ENCASTRER HDD
DEMI LUNE MASSIF OLD SILVER**

A = 40MM: €

A = 43MM: €

* = ART. **3.120.300**

* = ART. **3.921.300**

(per stuk/la piece)

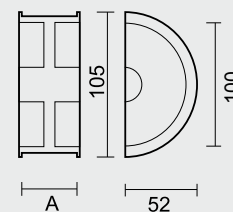

PRO★INOX PLUS
PROFESSIONAL QUALITY LABEL

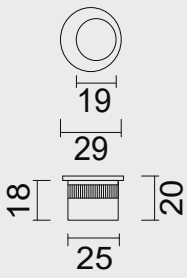

PRO★FINISH
100% ITALIAN MANUFACTURE

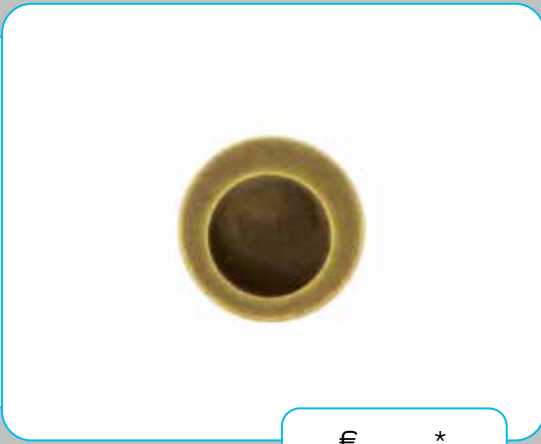

€ *

INKAPSCHELP FRA
VINGERTOP OLD YELLOW

COQUILLE A ENCASTRER FRA
POINTE DE DOIGT OLD YELLOW

ART. **3.446.310**
(per stuk/la piece)

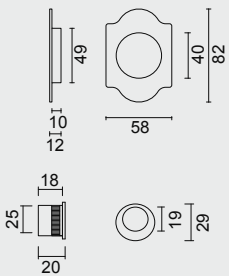

PRO★FINISH
100% ITALIAN MANUFACTURE

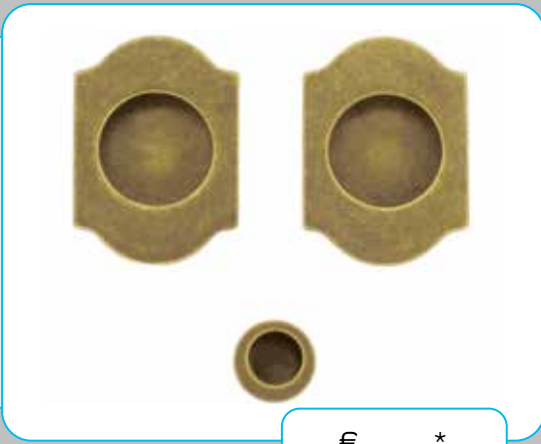

€ *

INKAPSCHELP FRA
RETRO CARRE OLD YELLOW

COQUILLE A ENCASTRER FRA
RETRO CARREE OLD YELLOW

ART. **3.444.310**
(per set/le set)

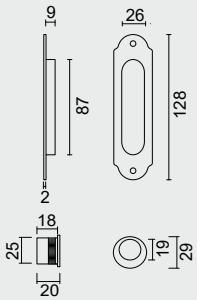

PRO★FINISH
100% ITALIAN MANUFACTURE



€ *

INKAPSCHELP FRA
RETRO OVAAL OLD YELLOW

COQUILLE A ENCASTRER FRA
RETRO OVALE OLD YELLOW

ART. **3.445.310**
(per set/le set)

INCL. 4X 15MM

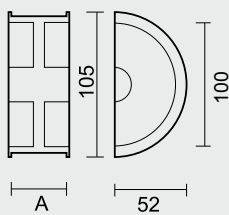

PRO★INOX PLUS
PROFESSIONAL QUALITY LABEL



INKAPSCHELP HDD
HALVE MAAN MASSIEF OLD YELLOW

COQUILLE A ENCASTRER HDD
DEMI LUNE MASSIF OLD YELLOW

A = 40MM: € * = ART. **3.120.310**

A = 43MM: € * = ART. **3.921.310**

(per stuk/la piece)

INKAPSCHELP **HDD**
HALVE MAAN MASSIEF KOPER

COQUILLE A ENCASTRER **HDD**
DEMI LUNE MASSIF LAITON

A = 40MM: € * = ART. **3.120.040**

A = 43MM: € * = ART. **3.921.040**
(per stuk/la piece)

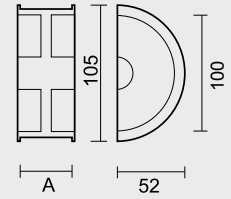

PRO★INOX PLUS
PROFESSIONAL QUALITY LABEL

INKAPSCHELP **FRA**
OVAAL KOPER

COQUILLE A ENCASTRER **FRA**
OVALE LAITON

ART. **3.126.040**
(per set/le set)

INCL. **4X** **15MM**

€ *

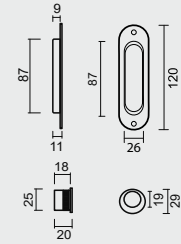

PRO★FINISH
100% ITALIAN MANUFACTURE

INKAPSCHELP **FRA**
OVAAL+SLOT KOPER

COQUILLE A ENCASTRER **FRA**
OVALE+SERRURE LAITON

ART. **3.126.042**
(per set/le set)

INCL. **8X** **15MM**

€ *

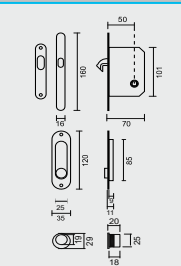
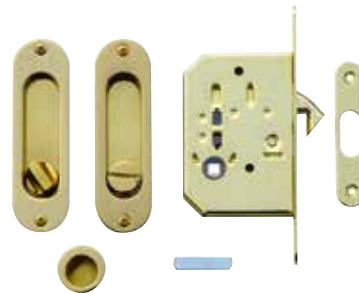

PRO★FINISH
100% ITALIAN MANUFACTURE

INKAPSCHELP **FRA**
ROND KOPER

COQUILLE A ENCASTRER **FRA**
RONDE LAITON

ART. **3.127.040**
(per set/le set)

€ *

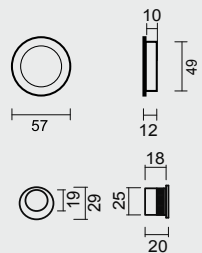
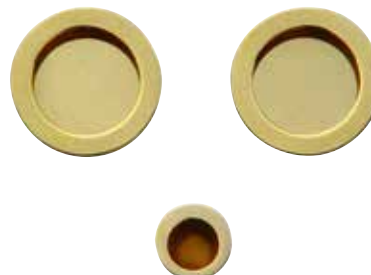

PRO★FINISH
100% ITALIAN MANUFACTURE

INKAPSCHELP **FRA**
CARRE KOPER PER SET

COQUILLE A ENCASTRER **FRA**
CARREE LAITON LE SET

ART. **3.128.040**
(per set/le set)

€ *

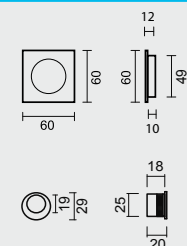

PRO★FINISH
100% ITALIAN MANUFACTURE

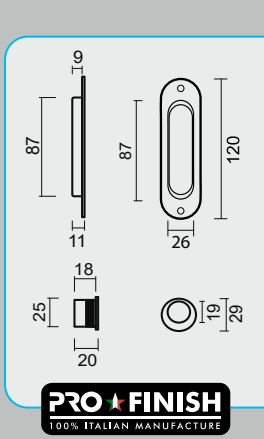

PRO FINISH
100% ITALIAN MANUFACTURE



€ *

INKAPSCHELP FRA
OVAAL BRONS

COQUILLE A ENCASTRER FRA
OVALE FUME

ART. **3.126.060**
(per set/le set)

INCL. 4X 15MM

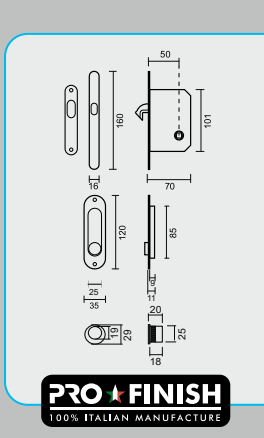

PRO FINISH
100% ITALIAN MANUFACTURE

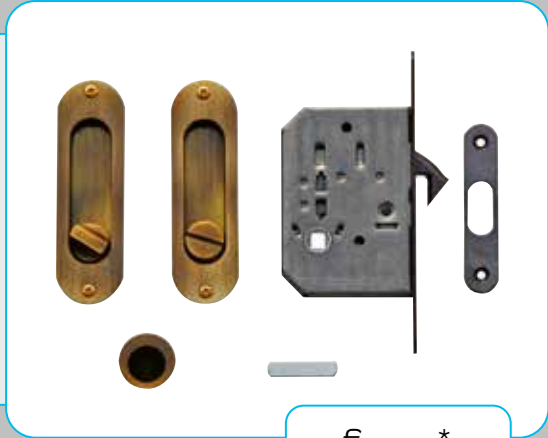

€ *

INKAPSCHELP FRA
OVAAL+SLOT BRONS

COQUILLE A ENCASTRER FRA
OVALE+SERRURE FUME

ART. **3.126.062**
(per set/le set)

INCL. 8X 15MM

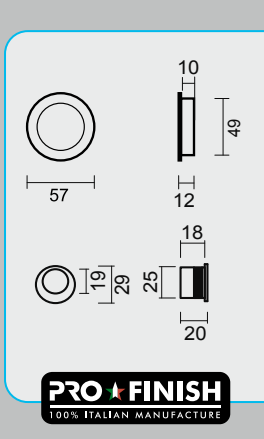

PRO FINISH
100% ITALIAN MANUFACTURE

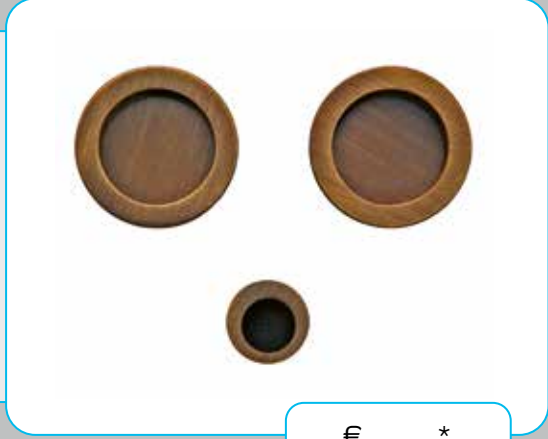

€ *

INKAPSCHELP FRA
ROND BRONS

COQUILLE A ENCASTRER FRA
RONDE FUME

ART. **3.127.060**
(per set/le set)

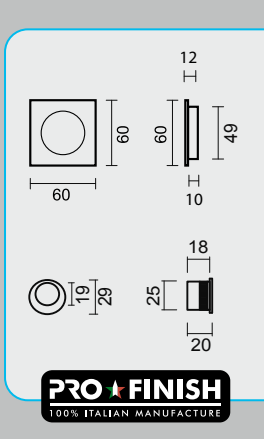

PRO FINISH
100% ITALIAN MANUFACTURE

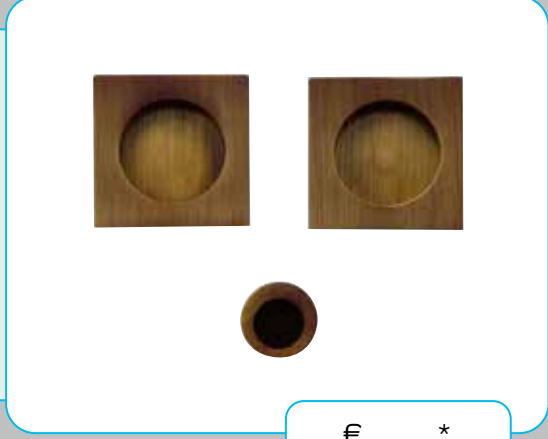

€ *

INKAPSCHELP FRA
CARRE BRONS

COQUILLE A ENCASTRER FRA
CARREE FUME

ART. **3.128.060**
(per set/le set)

INKAPSCHELP **HDD OVAAL**
BLIND MAT BRONS

COQUILLE A ENCASTRER **HDD OVALE**
AVEUGLE FUME MAT

ART. **3.538.420**
(per stuk/la piece)

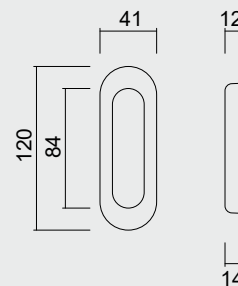

PRO★INOX PLUS
PROFESSIONAL QUALITY LABEL

€ *

INKAPSCHELP **HDD OVAAL CARRE**
SMAL BLIND MAT BRONS

COQUILLE A ENCASTRER **HDD OVALE**
CARRE FIN AVEUGLE FUME MAT

ART. **3.539.420**
(per stuk/la piece)

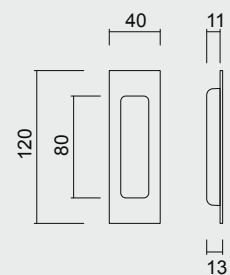

PRO★INOX PLUS
PROFESSIONAL QUALITY LABEL

€ *

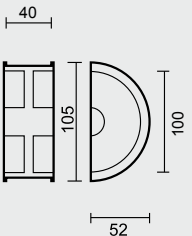

PRO★INOX PLUS
PROFESSIONAL QUALITY LABEL

€ *

**INKAPSCHELP HDD HALVE MAAN
MASSIEF 40MM MAT BRONS**

**COQUILLE A ENCASTRER HDD DEMI
LUNE MASSIF 40MM FUME MAT**

ART. 3.120.420
(per stuk/la piece)

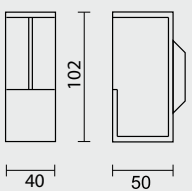

PRO★INOX PLUS
PROFESSIONAL QUALITY LABEL

€ *

**INKAPSCHELP HDD CARRE MASSIEF
40MM MAT BRONS**

**COQUILLE A ENCASTRER HDD CARREE
MASSIF 40MM FUME MAT**

ART. 3.119.420
(per stuk/la piece)

INKAPSCHELP **FRA**
VINGERTOP CARBON BLACK

COQUILLE A ENCASTRER **FRA**
POINTE DE DOIGT CARBON BLACK

ART. **3.446.320**
(per stuk/la piece)

CARBON BLACK =
ANTRACIET DONKERGRIJS / ANTRACITE GRIS FONCE

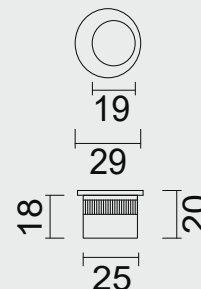

PRO★BLACK
10 YEARS GUARANTEE SUPPORT

€ *

INKAPSCHELP **FRA**
OVAAL CARRE CARBON BLACK

COQUILLE A ENCASTRER **FRA**
OVALE CARREE CARBON BLACK

ART. **3.469.320**
(per set/le set)

INCL. **4X** **15MM**

CARBON BLACK =
ANTRACIET DONKERGRIJS / ANTRACITE GRIS FONCE

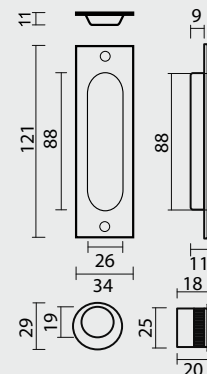

PRO★BLACK
10 YEARS GUARANTEE SUPPORT

€ *

INKAPSCHELP **FRA**
RETRO OVAAL CARBON BLACK

COQUILLE A ENCASTRER **FRA**
RETRO OVALE CARBON BLACK

ART. **3.445.320**
(per set/le set)

INCL. **4X** **15MM**

CARBON BLACK =
ANTRACIET DONKERGRIJS / ANTRACITE GRIS FONCE

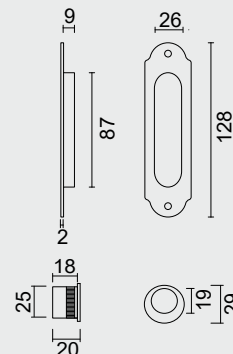

PRO★BLACK
10 YEARS GUARANTEE SUPPORT

€ *



Technical drawing showing dimensions: 18, 19, 29, 20, 25.

PRO FINISH
100% ITALIAN MANUFACTURE

€ *

- INKAPSCHELP FRA VINGERTOP ROSA
- COQUILLE A ENCASTRER FRA POINTE DE DOIGT ROSA
- ART. **3.446.360**
(per stuk/la piece)

Technical drawing showing dimensions: 49, 12, 10, 18, 25, 20, 58, 40, 82, 19, 29.

PRO FINISH
100% ITALIAN MANUFACTURE

€ *

- INKAPSCHELP FRA RETRO CARRE ROSA
- COQUILLE A ENCASTRER FRA RETRO CARREE ROSA
- ART. **3.444.360**
(per set/le set)

Technical drawing showing dimensions: 11, 121, 88, 88, 26, 34, 19, 29, 25, 18, 20, 9.

PRO FINISH
100% ITALIAN MANUFACTURE

€ *

- INKAPSCHELP FRA OVAAL CARRE ROSA
- COQUILLE A ENCASTRER FRA OVALE CARREE ROSA
- ART. **3.469.360**
(per set/le set)
- INCL. 4X 15MM

INKAPSCHELP **FRA**
VINGERTOP FONT

COQUILLE A ENCASTRER **FRA**
POINTE DE DOIGT FONT

ART. **3.446.370**
(per stuk/la piece)

FONT = ZWART MET RELIEF/
NOIR AVEC RELIEF

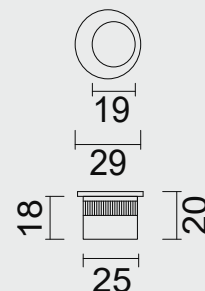

PRO★FINISH
100% ITALIAN MANUFACTURE

€ *

INKAPSCHELP **FRA**
RETRO CARRE FONT

COQUILLE A ENCASTRER **FRA**
RETRO CARREE FONT

ART. **3.444.370**
(per set/le set)

FONT = ZWART MET RELIEF/
NOIR AVEC RELIEF

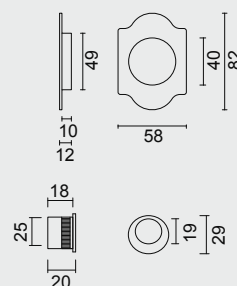

PRO★FINISH
100% ITALIAN MANUFACTURE

€ *

INKAPSCHELP **IJZER**

COQUILLE A ENCASTRER **FER**

ART. **3.130.080**
(per stuk/la piece)

INCL. 2X  15MM

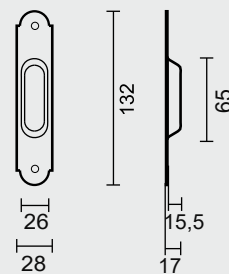

PRO★ART
HANDMADE IN FRANCE

€ *

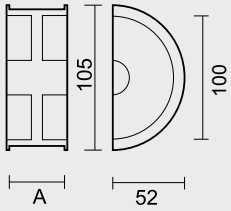

PRO ART
HANDMADE IN FRANCE



INKAPSCHELP **HDD**
HALVE MAAN MASSIEF IJZER

COQUILLE A ENCASTRER **HDD**
DEMI LUNE MASSIF FER

A = 40MM: € * = ART. **3.120.080**

A = 43MM: € * = ART. **3.921.080**

(per stuk/la piece)

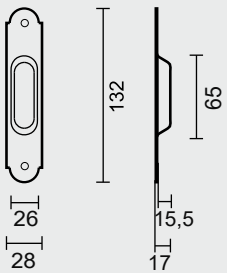

PRO ART
HANDMADE IN FRANCE



INKAPSCHELP **ROEST**

COQUILLE A ENCASTRER **ROUILLE**

ART. **3.130.070**

(per stuk/la piece)

INCL. **2X**  **15MM**

€ *

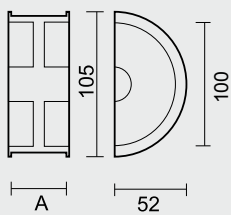

PRO ART
HANDMADE IN FRANCE



INKAPSCHELP **HDD**
HALVE MAAN MASSIEF ROEST

COQUILLE A ENCASTRER **HDD**
DEMI LUNE MASSIF ROUILLE

A = 40MM: € * = ART. **3.120.070**

A = 43MM: € * = ART. **3.921.070**

(per stuk/la piece)